

SteREO Discovery.V8 A New View of Things



**Brilliant Entry into the Class of
Sophisticated Stereomicroscopes**



We make it visible.

SteREO Discovery.V8: Enhanced Viewing

New high-performance optics – this is the outstanding performance feature that Carl Zeiss has focused on with the development of its latest entry level model in the sophisticated stereomicroscope class. The SteREO Discovery.V8 impresses with enhanced resolution, increased contrast and, most notably, a perceptibly improved stereoscopic impression. As a result, it offers a image brilliance that is without equal in this class of instrument. For a visible increase in information in all biomedical and industrial applications, the time has come for a new view of things.

SteREO Discovery.V8 at a glance:

- Supreme ease of operation and ergonomic viewing posture
- Zoom range of 8 : 1
- Optimized optics design for a visible increase in image information
- Manual focusing drive with adjustable click stops
- Manual and motorized stands with high stability
- Generous specimen space with high working distance
- Illumination and contrast methods based on cold light and LED



PCB
Laterally grazing reflected light
Objective: Plan S 1.0x
Magnification: 16x*

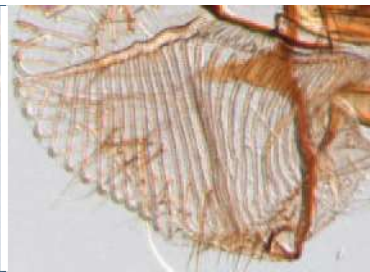

Mouth parts of the common housefly
Oblique illumination in brightfield
transmitted light
Objective: PlanApo S 1.0x
Magnification: 80x*

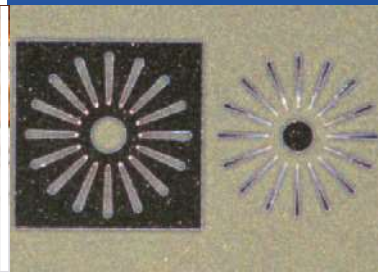

Wafer structure
Darkfield reflected light
Objective: PlanApo S 1.5x
Magnification: 120x*

SteREO Discovery.V8

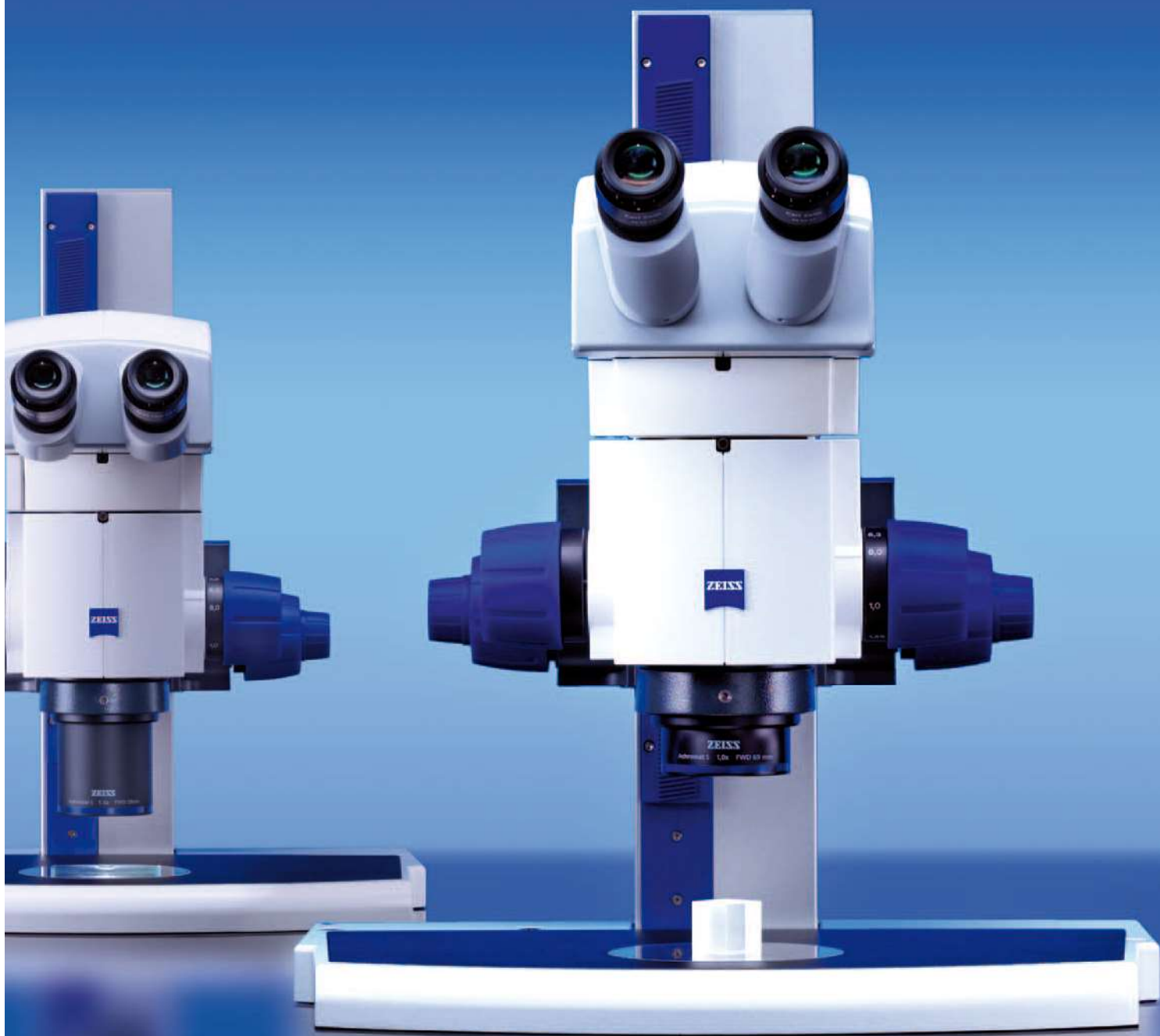

The Optical System: More Than the Sum of its Individual Components

Today, anyone developing a stereomicroscope that sets new standards with its optical system has to work constructively at the very limits of physical feasibility, taking full advantage of every new possibility offered by state-of-the-art optical design. With experience and innovativeness, you don't have to look any further than the optical systems from Carl Zeiss.

The innovative simultaneous design process during optical modeling has resulted in a standardized optical concept for all SteREO microscopes. For significantly improved resolution and a perceptibly better

stereoscopic impression of the microscopic image. Even on our SteREO Discovery.V8 entry level model.

Another area we focused on during practical realization was the systematic minimization of stray light for the entire optical system. For exceptionally brilliant contrast and a new image quality with greater information content.

*3 ranges of high-quality objectives
Achromat S: high-contrast images with a pronounced stereoscopic impression
Plan S: flat, distortion-free object fields
PlanApo S: precisely detailed resolution with no color fringes*

Parfocally harmonized for needle-sharp images over the entire magnification range from 1x to 8x: the new zoom body of SteREO Discovery.V8

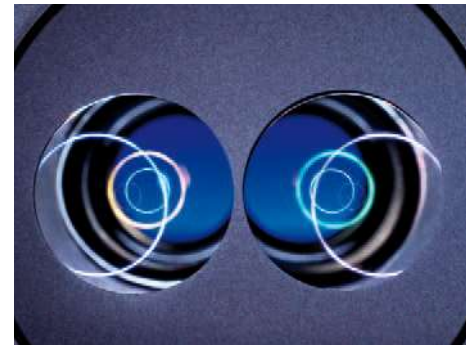

Contrasts with variable optimization in brightfield, darkfield and oblique light: the transmitted light equipment S



The Illumination: Show Your Specimen in a New Cold Light

The quality of the illumination – this is all-important for contrasting in stereomicroscopy. The new fiber-optic CL 1500 ECO cold light source with its wide range of light guides and accessories offers you a variety of opportunities for highlighting your structures perfectly.

Designed for slimline, space-saving light guides, optimized for flicker-free live images on the monitor, providing constant light output even if the line voltage fluctuates, and with ventilation as quiet as a whisper – the high-intensity CL 1500 ECO cold light

source outperforms conventional fiber-optic systems thanks to several practical advantages, and offers excellent performance at a superb price!

Incidentally, lamps and filters can be changed quickly and conveniently. Even when stacked.

The fiber-optic CL 1500 ECO cold light source illuminates the specimen precisely with intensive infrared-free light. Here with a twin-arm goose neck for oblique reflected light with a targeted shadow effect.

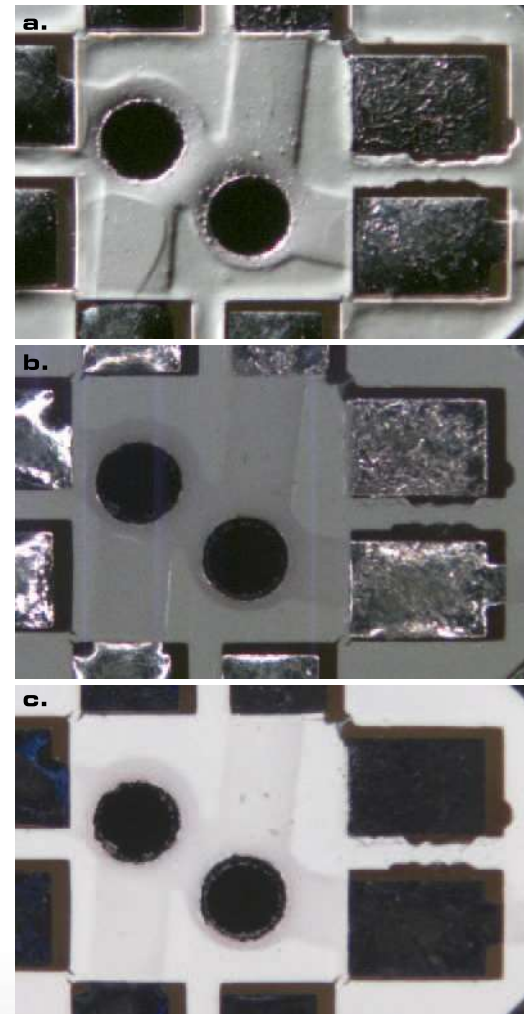

SMD-Board with white solder resist
Reflected light with different light guides
a. Linear slit light for lateral grazing light
b. Fiber-optic annular slit illuminator for shadow-free 360° reflected light
c. Annular slit illuminator with polarization filter device to minimize reflective glare
Objective: Plan S 1.0x
Magnification: 15x

Quiet, durable and offering the best in daylight quality: VisiLED LED illumination

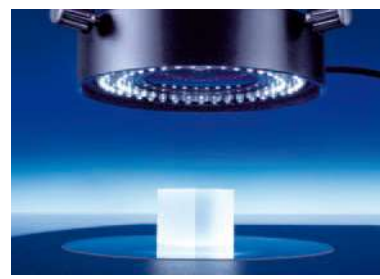

Or in a Completely Different Light: With White LEDs

Providing the ability to change rapidly from shadow-free annular illumination to lateral oblique light, contrast optimization through turning of oblique light around the specimen, continuous rotation of the illumination for a stereoscopic impression of the object in the live image – and all this at the push of a button! The list of new contrasting possibilities offered by the VisiLED illumination system with its white LEDs is endless!

Each of the annular VisiLED illuminators is made up of eight LED segments that can be switched variably. A further advantage of noise-free light sources: up

to 4 illumination settings can be stored and reproduced again at any time.

The MC1500 multicontroller of the VisiLED system allows control of reflected, transmitted and blended light.

The VisiLED HCT contrast stage offers a wide range of contrasts. It contains separate LED illuminators for brightfield and darkfield, and sliders for finely adjustable oblique light. The LEDs are controlled using the MC1500 multicontroller.

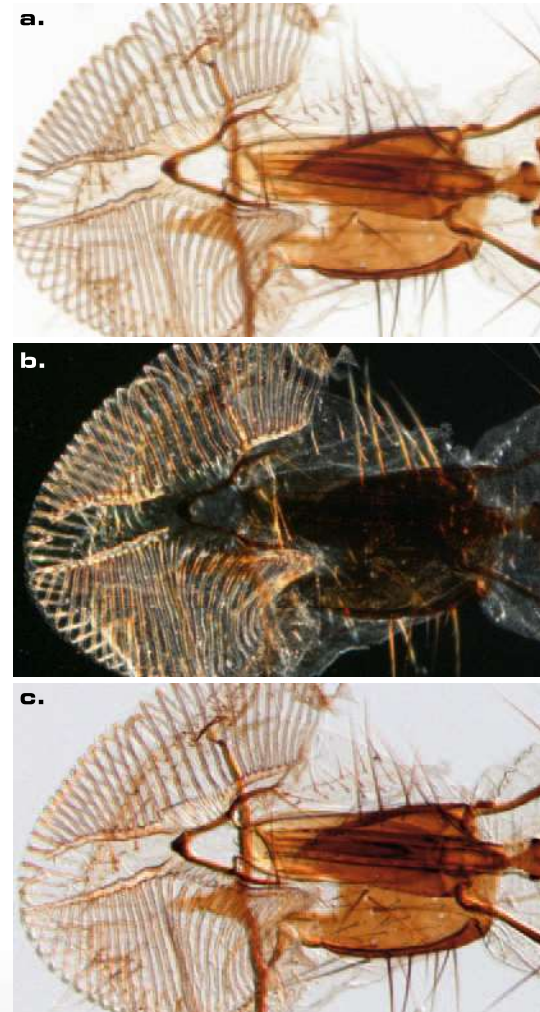

Mouth parts of the common housefly
Transmitted light with VisiLED HCT contrast stage
a. Brightfield
b. Lateral darkfield
c. Oblique brightfield illumination
Objective: PlanApo S 1.0x
Magnification: 80x

The Expandable Platform: Flexible For a Variety of Applications

A typical feature of stereomicroscopes is their modular system design. Equipped with intelligent interfaces and fully integrated into the Carl Zeiss systems, SteREO Discovery.V8, with its comprehensive range of accessories, offers you a great deal of freedom in terms of organizing your workplace to suit your own practical needs.

1. Interface with digital image worlds: documentation

SteREO Discovery.V8 creates a connection for a variety of digital photo and video cameras, via various phototubes, with interface 60N. For the simple documentation of stereomicroscopic images, consumer cameras, with their good price/performance ratio, are often recommended. Anyone wishing to satisfy higher demands should use the high-resolution AxioCam microscope cameras and the AxioVision imaging software from Carl Zeiss.

2. Brilliant fluorescence: PentaFluar S

PentaFluar S is the name of the retrofitable fluorescence equipment for stereomicroscopes belonging to the SteREO Discovery family. With up to five different filter blocks in the magazine and special high-performance light sources, this is an outstanding addition for contemporary fluorescence applications in stereomicroscopy.

3. Better in position: the binocular ergo-phototube S 5-45°

Ergonomics is also about choosing a relaxed sitting position when operating a microscope. The viewing angle and height have to coincide. The ergotube allows a free choice of viewing angle between 5 and 45 degrees. Intermediate tubes and two working positions for the eyepiece clamps vary the viewing height.

4. Vertical 2D impression: the objective slide

A must for documentation with subsequent image analysis, e.g. digital object measurements: the S/doc objective slide for the SteREO Discovery family of microscopes. Positioned directly beneath the zoom body, it enables the objective to be shifted precisely under one of the stereoscopic beam path for a vertical view of your specimen.



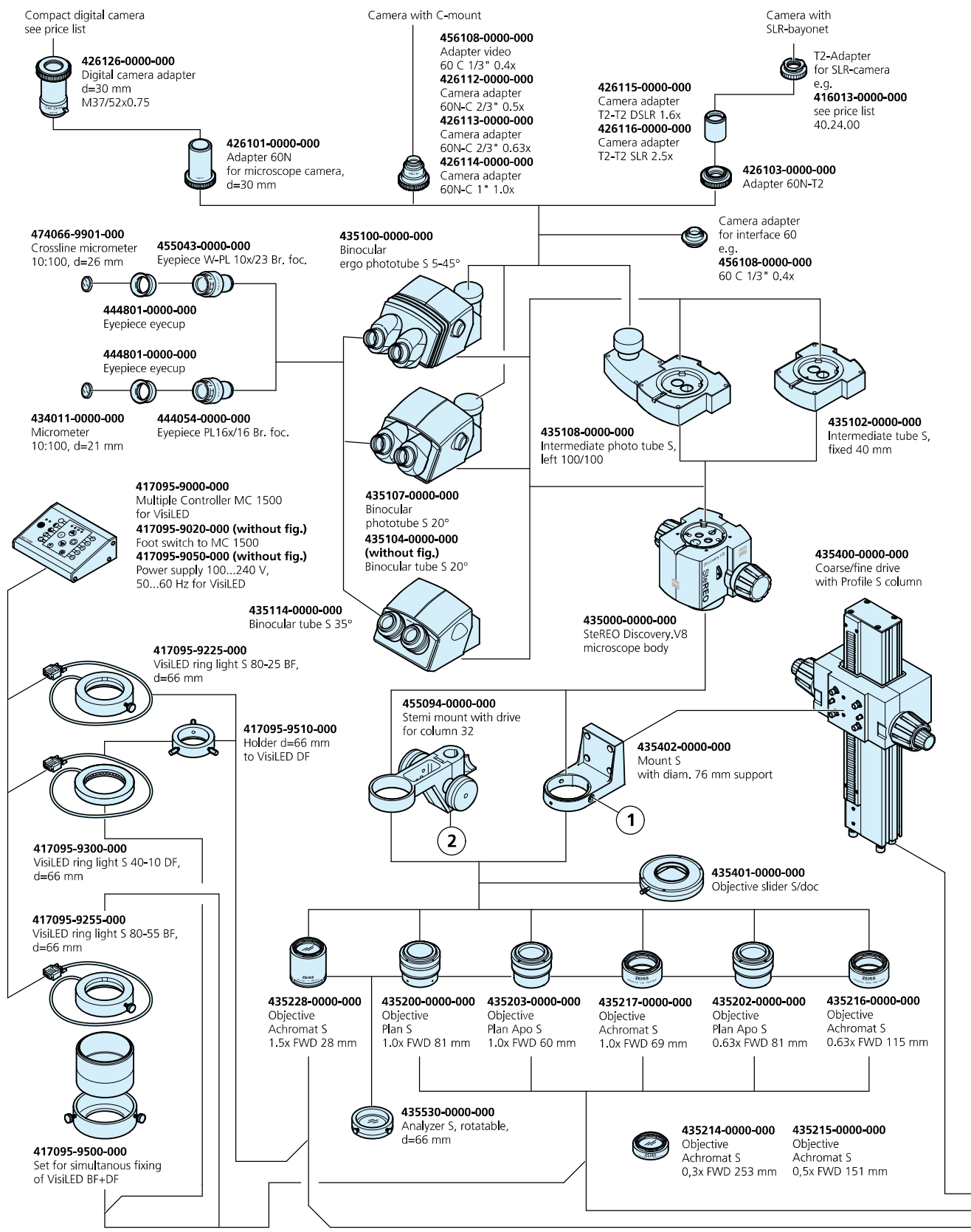

System Overview

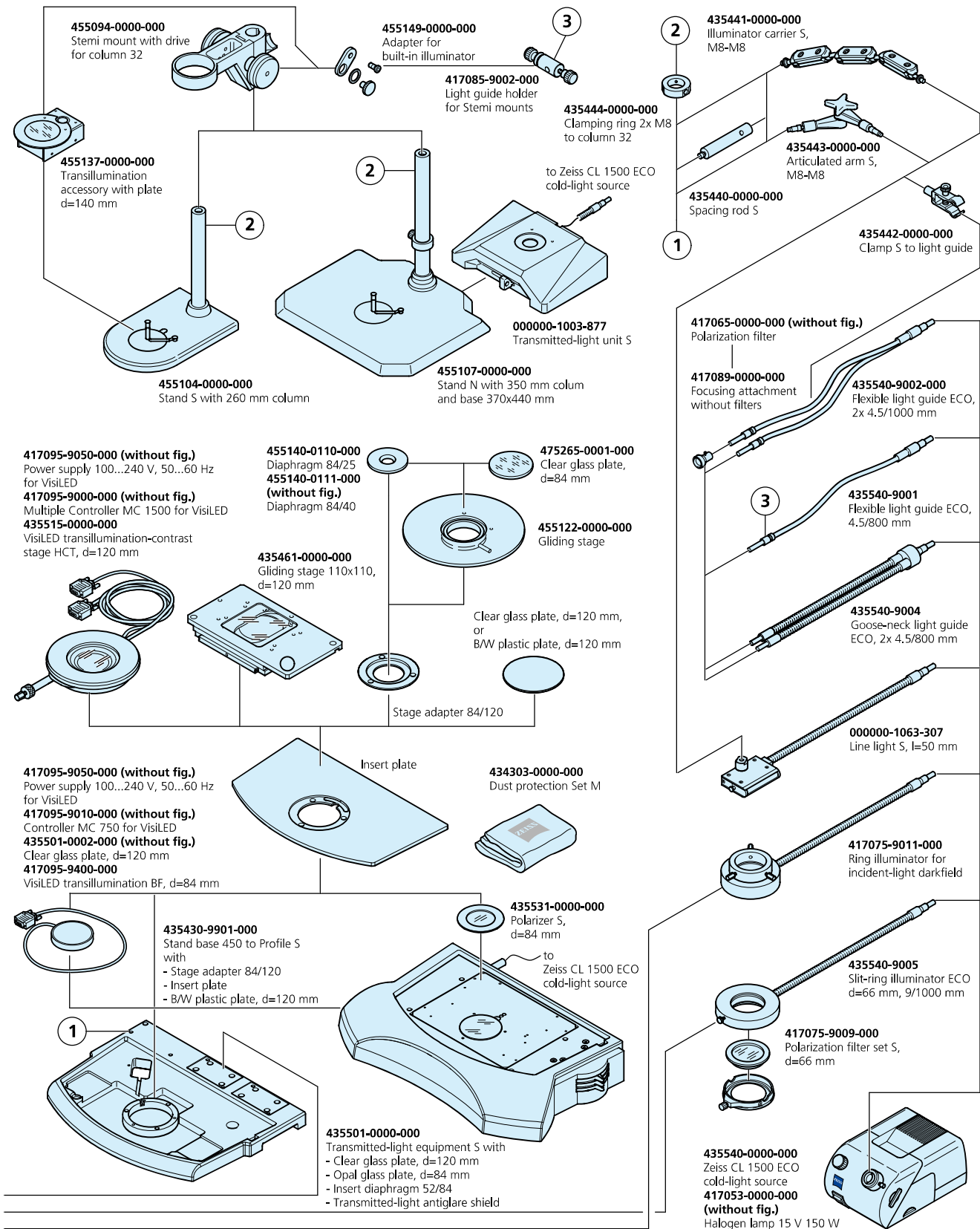

SteREO Discovery.V8:

The Technical Data

Objectives		Eyepieces					
Description	FWD (mm)	WPL 10x/23 Br. foc		PL 16x/16 Br. foc		W 25x/10 foc	
Factor		Magnification	Object Field (mm)	Magnification	Object Field (mm)	Magnification	Object Field (mm)
PlanApo S 0,63x	81	6,3x ... 50,4x	36,5 ... 4,6	10,1x ... 80,6x	25,4 ... 3,2	15,8x ... 126x	15,9 ... 2,0
PlanApo S 1,0x	60	10x ... 80x	23,0 ... 2,9	16x ... 128x	16,0 ... 2,0	25x ... 200x	10,0 ... 1,3
PlanApo S 1,5x	30	15x ... 120x	15,3 ... 1,9	24x ... 192x	10,7 ... 1,3	37,5x ... 300x	6,7 ... 0,8
Plan S 1,0x	81	10x ... 80x	23,0 ... 2,9	16x ... 128x	16,0 ... 2,0	25x ... 200x	10,0 ... 1,3
Achromat S 0,3x	253	3x ... 24x	76,7 ... 9,6	4,8x ... 38,4x	53,3 ... 6,7	7,5x ... 60x	33,3 ... 4,2
Achromat S 0,5x	151	5x ... 40x	46,0 ... 5,8	8x ... 64x	32,0 ... 4,0	12,5x ... 100x	20,0 ... 2,5
Achromat S 0,63x	115	6,3x ... 50,4x	36,5 ... 4,6	10,1x ... 80,6x	25,4 ... 3,2	15,8x ... 126x	15,9 ... 2,0
Achromat S 1,0x	69	10x ... 80x	23,0 ... 2,9	16x ... 128x	16,0 ... 2,0	25x ... 200x	10,0 ... 1,3
Achromat S 1,5x	28	15x ... 120x	15,3 ... 1,9	24x ... 192x	10,7 ... 1,3	37,5x ... 300x	6,7 ... 0,8

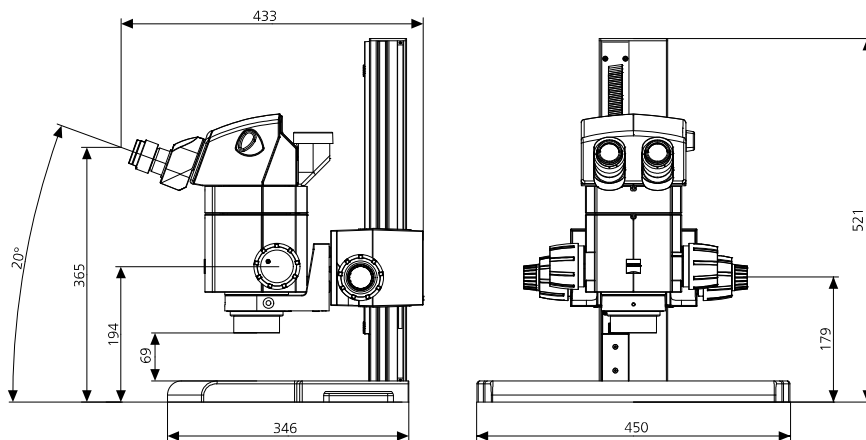

Carl Zeiss Microscopy GmbH
 07745 Jena, Germany
 microscopy@zeiss.com
 www.zeiss.de/steereo-discovery

Subject to change.
 Printed on environmentally-friendly
 paper, bleached without the use of
 chlorine.